

WF-8930/50 Series Distribution Centers

WF-8930/50NP | WF-8930/50NP-30 |

(The Distribution Center model number is located on the front panel label near the AC breakers)

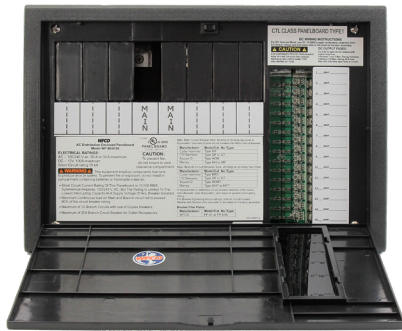

THE HEARTBEAT OF TODAY'S RVs

Distributed in the U.S.A. and Canada by
ARTERRA DISTRIBUTION

(877) 294-8997

Warranty: warranty@wfcoelectronics.com

Fax (574) 294-8698

www.wfcoelectronics.com



EXPERT PRODUCT SUPPORT

Power PROs Technical Support
(877) 294-8997

TABLE OF CONTENTS

SAFETY INFORMATION	3
GENERAL INFORMATION	
Reverse Battery Protection	3
Blown Fuse Indicators	3
CIRCUIT PROTECTION	
DC Fuses	4
AC Circuit Breaker	4
UL-Listed Main Circuit Breaker List	4
UL-Listed Branch Circuit Breaker List	5
TROUBLESHOOTING INSTRUCTIONS	
Check Converter or Battery Input Voltage	6
Blown Fuse Indicators	6
GENERAL COMPLIANCE INFORMATION	
Agency Listings	7
INSTALLATION INSTRUCTIONS	
Mounting the Enclosure	7
Wiring the AC Breakers	8
Wiring the DC Fuse Board	9
WARRANTY INFORMATION	10





⚠ WARNING
RISK OF ELECTRICAL SHOCK Disconnect or isolate all power supplies before making electrical connections. More than one disconnection or isolation may be required to completely de-energize equipment. Contact with components carrying hazardous voltage can cause electric shock and may result in severe personal injury or death.
NOTICE
All wiring must conform to local, national, and regional regulations. Use copper conductors only for all wire connections. Do not exceed the electrical ratings for the WF-8930/50 Series Distribution Panel as this may cause equipment failure and/or electrical shock which may result in severe personal injury or death.
⚠ CAUTION
INSTALLATION AND SERVICING This product should be installed and serviced by a certified or licensed electrician familiar with applicable safety codes and installation requirements. Failure to observe this precaution could result in electrical shock or bodily injury. Consult your servicing dealer before attempting any work on this product.
⚠ WARNING
SPARK HAZARD This unit employs components that can produce arcs or sparks. To prevent fire or explosion, do not install in compartments containing batteries or flammable materials (LP gas). This product is NOT ignition protected.

GENERAL INFORMATION

WF-8930/50 Series Distribution Center Safety Features

Reverse Battery Protection

The WF-8930/50 Series Distribution Centers DO NOT have a converter installed within the enclosure. Power is supplied to the WF-8930/50 Series Distribution Centers from an external converter/charger, WF-9800 Series Converter/Charger for example, located elsewhere in the RV. Reverse Battery Protection will be provided by that unit. Consult that converter/charger's manual for location and replacement instructions.

Blown Fuse Indicators on DC Fuse Board

The DC Fuse Board has individual blown fuse indicators as standard equipment. The WF-8930/50 Series Distribution Centers have 15 DC circuits. Each of the circuits contain a Red LED to indicate a blown fuse. If one of the circuits draws more current than the rating of the fuse, the fuse will blow. When this occurs, the Red LED for that circuit will illuminate. **NOTE:** The fuse board employs surface mount LEDs which are barely visible to the naked eye. Replace the blown fuse with a known good fuse of the same rating. **NOTE:** If the replacement fuse blows again, check that circuit for a short or overload condition.

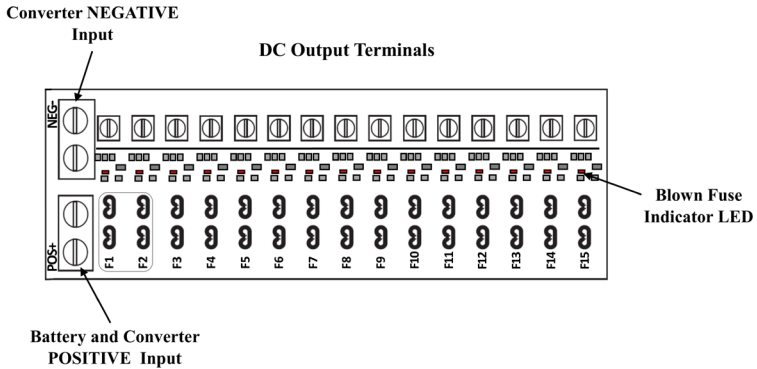

Figure 1

CIRCUIT PROTECTION WF-8930/50 Series Distribution Center Fuses and Breakers

DC Fuses (12 Volts)

The DC fuse board is located on the right side of the enclosure. The board has lugs on the top side for the Converter and Battery connections. Spaces for the 15 Branch circuits are located below these lugs. Should any of fuses blow, the fuses should be replaced with ATC or ATO automotive type fuses such as:

- Littelfuse type 257
- Bussmann type ATC

AC Circuit Breakers (120/240 Volts)

The AC Breaker side of the WF-8930/50 Series Distribution Center is located on the left side of the enclosure at the top. The WF-8930/50 Series Distribution Center accepts standard residential breakers. The WF-8930/50NP has spaces for two 50 Amp (or one 30 Amp) Main breakers and up to 12 Branch breakers when using duplex breakers. The WF-8930/50NP-30 has spaces for a 30 Amp Main and up to 6 Branch breakers when using duplex breakers. A list of factory tested and approved breakers follows. The breakers may be purchased at most big-box department stores and home centers.

UL-Listed Main Circuit Breakers, Rated for 120V, Maximum 30A

The following breakers have been factory tested and approved for use as 30 Amp Main breakers in the WF-8930/50 Series Distribution Center:

Manufacturer	Model/Cat. No./Type
Cutler Hammer	Type BR and C
Thomas Betts	Type TB or TBBD
ITE/Siemens	Type QP or QT
Square D	Type HOM or HOMT
Murray	Type MP-T or MH-T
General Electric	Type THQL

UL-Listed Branch Circuit Breakers, Rated for 120V, Maximum 20A

The following breakers have been factory tested and approved for use as Branch breakers in the WF-8930/50 Series Distribution Center:

Manufacturer	Model/Cat. No./Type
Cutler Hammer	Type BR and C, Type BRD, BD and A
Thomas Betts	Type TB or TBBD
ITE/Siemens	Type QP or QT
Square D	Type HOM or HOMT
Murray	Type MP-T or MH-T
General Electric	Type THQL

When replacing any of the installed circuit breakers, the replacement should be of the same manufacturer, type designation, and equal interrupting rating, not to exceed 30 A. The "Short-Circuit-Current" rating for the breaker should be 10,000 Amps.

Breaker Filler Plates: Model #FP-01 or FP-01B (Black)

Wiring the WF-8930/50 Distribution Panel for 30 Amp AC Service

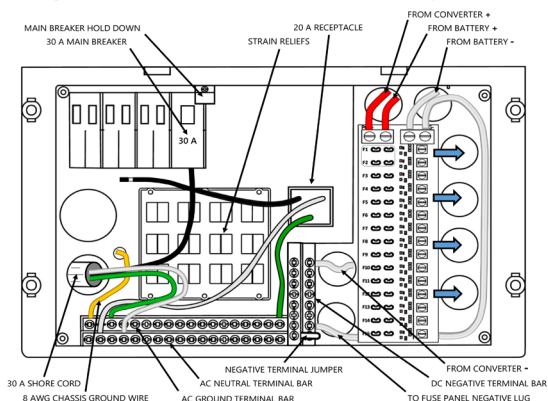

Wiring the WF-8930/50 Distribution Panel for 50 Amp AC Service

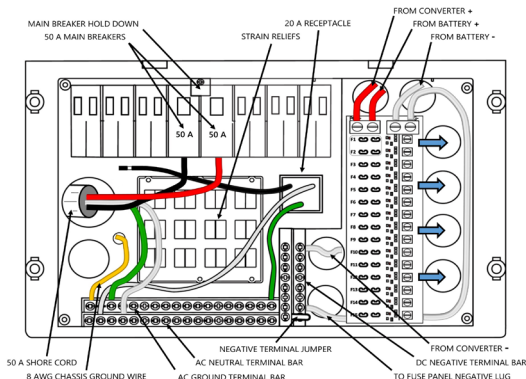

Figure 2



TROUBLESHOOTING INSTRUCTIONS

Troubleshooting the WF-8700 Series Power Center

Because the WF-8930/50 Series Distribution Centers do not contain a converter/charger, troubleshooting will be limited to checking DC power coming into the unit and proper fuse board operation. See (figure 1) on page 4.

Check for Converter or Battery Input Voltage

Note: Depending on how the RV manufacturer connected the DC power to the WF-8930/50 Series Distribution Center, it could have been routed in one of 2 ways.

1. Power could be coming directly into the WF-8930/50 Series Distribution Center fuse board from the converter/charger. The battery (if supplied) would also connect to the fuse board.
2. Power from the converter charger would be connected directly to the battery. A cable from the battery would be connected to the fuse boards input lugs.

We'll use the first connection method in our discussion below.

Make sure the WF-8930/50 Series Distribution Center is receiving DC power from the converter/charger or battery. First, check that the converter/charger is plugged into an AC source (105-130 VAC) and is operating. Check the converter input voltage at the top lugs of the fuse board with a voltmeter. Be sure you have good cable connections at the lugs. Place the meter probes on the lugs as follows; place the Positive (red) meter probe on the + POS lug and place the Negative (black) meter probe on the NEG- lug. If the voltage from the converter charger reads approximately 13.6 VDC (+/- 0.2) at the lugs, the fuse board is getting DC power.

If no converter/charger/battery input voltage is read at these lugs, check for an open inline fuse or disconnect switch in circuit coming to the fuse board. One may have been installed by the RV manufacturer. Also check for any other loose wiring connections.

Blown Fuse Indicators on DC Fuse Board

The DC Fuse Board has individual blown fuse indicators as standard equipment. Each circuit has a Red LED to indicate a blown fuse. **NOTE:** The fuse board employs surface mount LEDs which are barely visible to the naked eye. If one of the Red LEDs is illuminated, check for a blown fuse. If blown, replace the fuse with a known good fuse of the same rating. **NOTE:** If the replacement fuse blows again, check that circuit for a short or overload condition.

If, for some reason, one of the fuse board output circuits is connected to a load that has a switch that is turned OFF or an appliance that is turned OFF, the indicator LED will not illuminate even if the fuse is blown or removed from the fuse board. Turn the switch or appliance ON and re-check the fuse circuit with the fuse removed. If the LED still remains OFF, check for a broken wire to the switch or appliance.

If an indicator LED remains illuminated with the known good fuse in place, check for possible damage to the fuse board at that location. If damage is found, the fuse board will need to be replaced.



If the above checks have been made but the problem cannot be resolved, contact the Arterra Distribution Power PROs at 1 (877) 294-8997. Before placing the call, please have available the WF-8930/50 Series Distribution Center model number from the front panel label and the 14-digit serial number from the bar code tag located inside the enclosure. Remove the door assembly to gain access to the inside to locate this serial tag.

Should it be determined that the fuse board of the WF-8930/50 Series Distribution Center is defective, and the unit is under still warranty, the fuse board ONLY will need to be returned. DO NOT return the complete WF-8930/50 Series Distribution Center.

The DC wires protruding from the back of the WF-8930/50 Series Distribution Center have been connected to the DC circuits in your RV by the RV manufacturer. When preparing the fuse board for return, label and disconnect each wire as it is removed from the fuse board lug. Follow the packaging instructions in your warranty claim packet.

GENERAL COMPLIANCE INFORMATION

Agency Listings

UL

The WF-8930/50 Series Distribution Centers are UL-Listed, and cUL-Listed (Canadian).

INSTALLATION INSTRUCTIONS

Installing the WF-8930/50 Series Distribution Center

Mounting the Enclosure

The WF-8930/50 Series Distribution Center enclosure should be mounted in an accessible area such as a wall or in the side of a cabinet near the Shore power entrance and battery (batteries). Select a mounting location that is appropriate to prevent excessive heat, water, moisture, dust and dirt entering the unit once installed.

Cut an opening 1/8" wider than the enclosure to allow the distribution center to slide in easily. The rough opening is 12 3/16" W x 8 3/16" H. The enclosure is 3" deep. Be sure to allow enough space behind the unit for wiring. After wiring is completed, the enclosure fastens to the wall or cabinet using 4 wood screws (not supplied).

WARNING

RISK OF ELECTRICAL SHOCK

Disconnect or isolate all power supplies before making electrical connections. More than one disconnection or isolation may be required to completely de-energize equipment. Contact with components carrying hazardous voltage can cause electric shock and may result in severe personal injury or death.



Two sizes of knockouts have been provided: a 34mm knockout for the 50 Amp and a 27mm knockout for the 30 Amp power cord. Eight 22mm holes are provided in the DC section for the 12 VDC loads. Wire clamps or strain reliefs must be used to tightly secure the wires wherever the wires enter the enclosure. Also provided is a series of built-in 120 VAC Romex strain reliefs and should only be used with 10-2 through 14-2 wire, placing one wire per strain relief opening.

Wiring the AC Breakers

Make sure no AC power is coming into the RV from either the Shore Power cord or an on-board generator. Determine the proper size breakers for the loads the WF-8930/50 Series Distribution Center will be powering. You can use either single or duplex breakers, or a combination of both. We recommend that all the breakers used be of the same brand. Two main breakers and up to 12 branch breakers can be installed in the WF-8930/50NP when using duplex breakers. One Main breaker and up to 6 Branch breakers can be installed in the WF-8930/50NP-30, again when using duplex breakers. Refer to the tables on pages 4 and 5 for a selection of approved breakers. The Main breakers should be installed in the center position. See the wiring diagrams below. A hold down clip is provided to keep the breaker securely in place.

CAUTION

INSTALLATION AND SERVICING

This product should be installed and serviced by a certified or licensed electrician familiar with applicable safety codes and installation requirements. Failure to observe this precaution could result in electrical shock or bodily injury. Consult your servicing dealer before attempting any work on this product.

The Shore cord should be routed through one of the large knockouts in the back of the wiring compartment as indicated above and secured with a Romex clamp. For 30 Amp service, the Black (Hot) wire is connected to the 30 Amp Main breaker. For 50 Amp service, the Black wire is connected to one of the 50 Amp Main breakers and the Red wire is connected to the other 50 Amp main breaker as shown. The White (Neutral) wire is connected to the Neutral Terminal bar at the bottom of the wiring compartment. The Green (Ground) wire is connected to the Ground Terminal bar also located at the bottom of the compartment.

Route the Romex leads for the Branch circuits through the Strain Reliefs in the back of the wiring compartment. In a similar fashion, connect the Black wire to the Branch breaker and the White and Green wires to the appropriate Terminal bar.

When wiring has been completed, make sure all terminals are torqued to the specifications listed on the back of the door assembly.

Wiring the WF-8930/50 Distribution Panel for 30 Amp AC Service

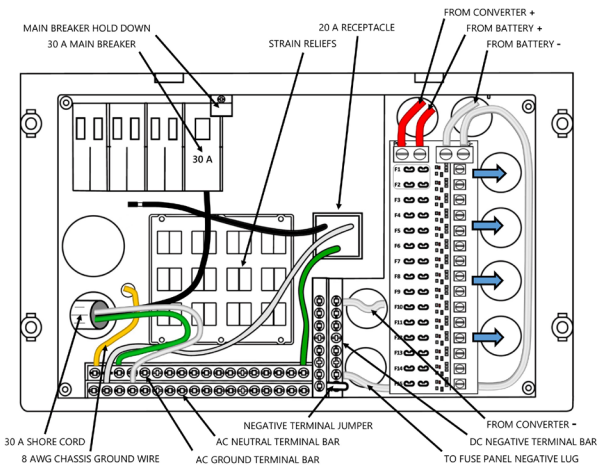

Wiring the WF-8930/50 Distribution Panel for 50 Amp AC Service

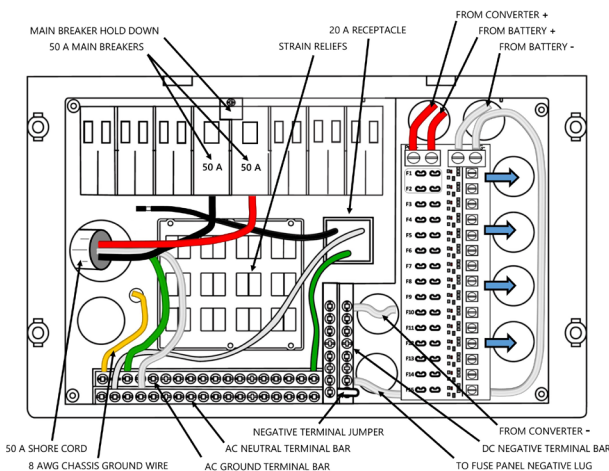

Figure 3

Wiring the DC Fuse Board

Make sure the converter/charger is OFF and the house battery is disconnected before beginning the DC wiring. Determine what DC loads are to be connected to the fuse board and what position they will occupy. Circuits F1 and F2 can be used for slide-outs or other higher current loads and can have a maximum 30 Amp ATO or ATC fuse installed. The remaining 13 circuits are general purpose and can have up to a 20 Amp ATO or ATC fuse installed. Make sure the fuses are seated properly.

All models have lug screw connections. Strip approximately 1/4" of insulation from the DC load wires and insert the wire into the appropriate lug. Tighten the lug screw to the torque spec found on the back of the door assembly. Make sure all connections are tightly secured.



Note: DC power coming to the WF-8930/50 Series Distribution Center could be routed in one of 2 ways.

1. Power could be coming directly into the WF-8930/50 Series Distribution Center fuse board from the converter/charger. The battery (if supplied) would also connect to the fuse board.
2. Power from the converter charger would be connected directly to the battery. A cable from the battery would be connected to the fuse boards input lugs.

We'll use the first connection method in our discussion below.

Connect the heavy Positive wire coming from the converter/charger to one of the **POS+** lugs of the fuse board. In a similar fashion, connect the heavy Negative wire from the converter/charger to the **NEG-** lug on the fuse board. Make sure the lugs are tightened to the specs in the torque chart locate on the back of the door assembly. Connect the battery Positive cable to the remaining **POS+** lug making sure it is torqued properly. The Negative battery lead will be connected below.

As a last step, any DC negative leads should be connected to the internal Negative bus bars located at the bottom left of the fuse board.

CONSUMER LIMITED WARRANTY for WFCO Electronic Products

WFCO extends, to the original owner, a Two Year Limited Product Warranty. This warranty is in effect from the date of original purchase for a period of two (2) years. This limited warranty is extended specifically for and is limited to Recreational Vehicle application and is only valid within the continental United States, Alaska, Hawaii and the Provinces of Canada. WFCO warrants, to the owner, that its products are free from defects in material and workmanship under normal use and service based on its intended use and function. This warranty is limited to the repair or replacement, at WFCO's discretion, of any defective parts or defective assembly. Any implied warranties of merchantability or fitness for intended use are limited in duration unless applicable State Law provides otherwise. You may have other rights as specified by each individual state.

EXCLUSIONS and LIMITATIONS

The OEM warranty specifically does not apply to the following:

- Any WFCO product that has been repaired or altered by an unauthorized person;
- Any damage caused by misuse, faulty installation, testing, negligence, accident or any WFCO product installed in a commercial vehicle;
- Any WFCO product, whose serial number has been defaced, altered or removed;
- Any WFCO product, whose installation has not been in accordance to the WFCO written instructions;
- Any consequential damages arising from the loss of use of the product including but not limited to: inconvenience, loss of service, loss of revenue, loss or damage to personal property, cost of all services performed in removing or replacing the WFCO product. Specifications are subject to change without notice or obligation.
- Any WFCO Electronics products sold through unauthorized Internet sources (Example: eBay) will be excluded from all warranty coverage offered by Arterra Distribution / WFCO.



CONSUMER WARRANTY CLAIM PROCEDURE

Upon determination and validation by an authorized OEM dealer that a WFCO product has a defect, a Return Goods Authorization (RGA) number will be required before the product can be returned. The RGA number can be requested by completing the Warranty Information Fax Sheet and appropriate Troubleshooting Form found at www.wfcoelectronics.com. Once these forms have been completed, email the forms along with Proof of Purchase to warranty@wfcoelectronics.com or fax the three documents to the Warranty Department at (574) 294-8698. After receipt of the forms, an RGA number will be issued. This number shall appear on all correspondence with warranty service. Upon validation of the warranty, WFCO shall replace the product with a like product. The RGA number shall be placed on the outside of the carton used to return the product for ease of identification. Do not mark directly on the product. The product must be packaged properly to avoid further product damage which could cause a non-warrantable condition.

WARRANTY ASSISTANCE

The consumer may contact the selling Dealer or OEM for warranty assistance. The consumer may also contact Arterra Distribution, exclusive distributor to WFCO Products at: (574) 294-8997 or Fax (574) 294-8698.

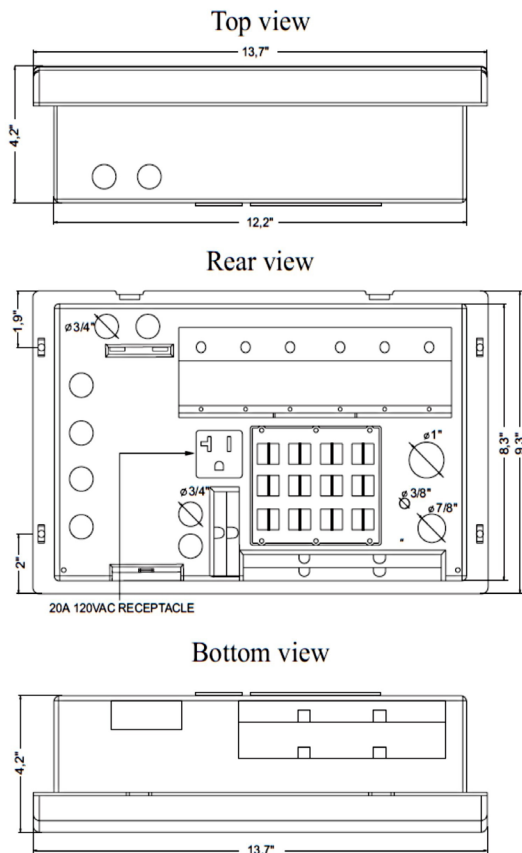

Figure 4



THE HEARTBEAT OF TODAY'S RVS

WFCOELECTRONICS.COM